

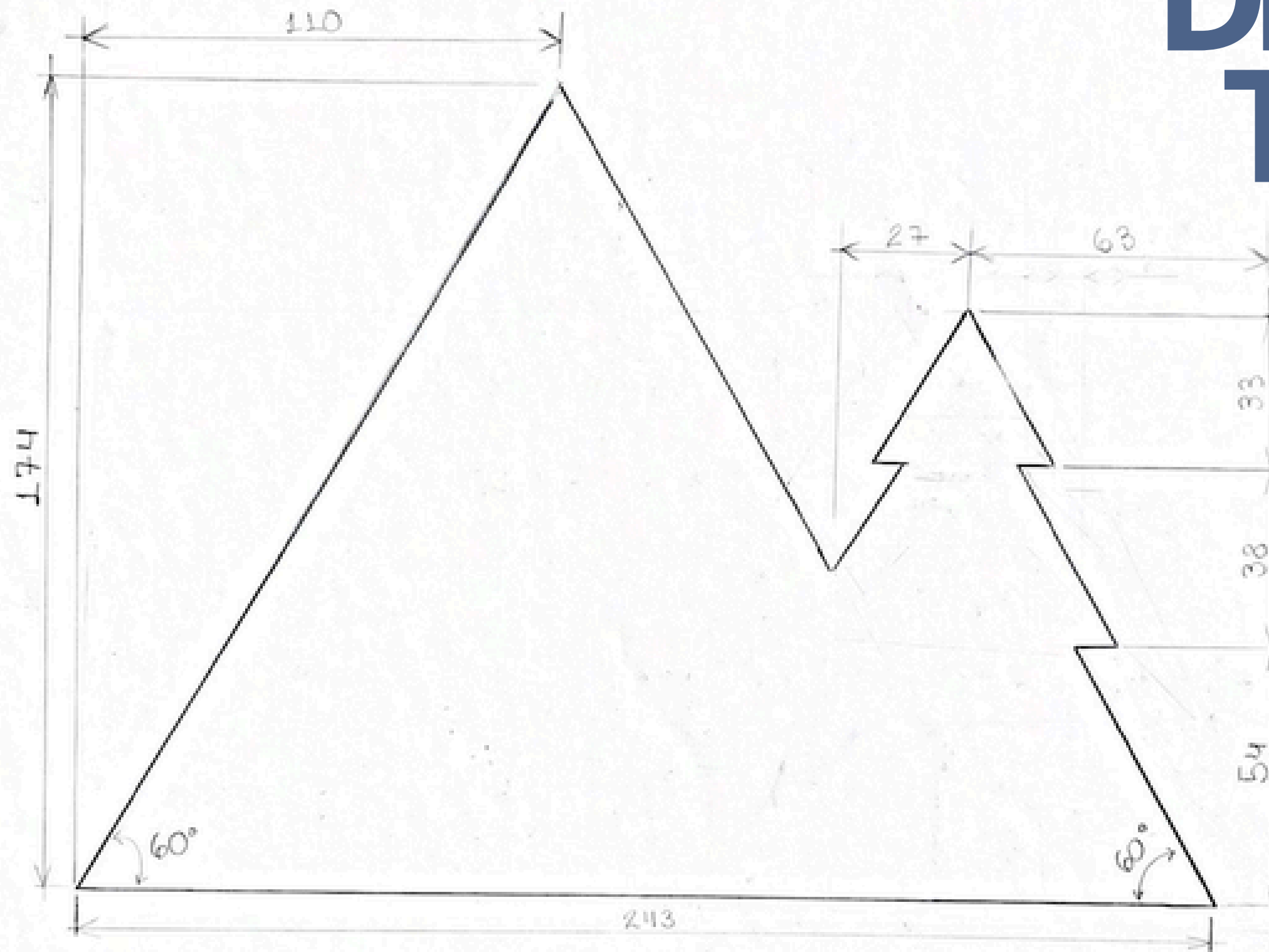

LUMINÁRIA MONTIS

DESENHO TECNICO



○ □ □	PEÇA FRONTAL	QUANT.: 2 UN.	MATERIAL: MDF
□ □	PROJETO 2 - LUMINÁRIA	ESC: 1:1	UN: mm
□ □ □	PROJETISTA: BEATRIZ VIEIRA	FOLHA: 1/3	
□ □	ORIENTADORA: MAIARA CAMILO	DESIGN: IFSC	

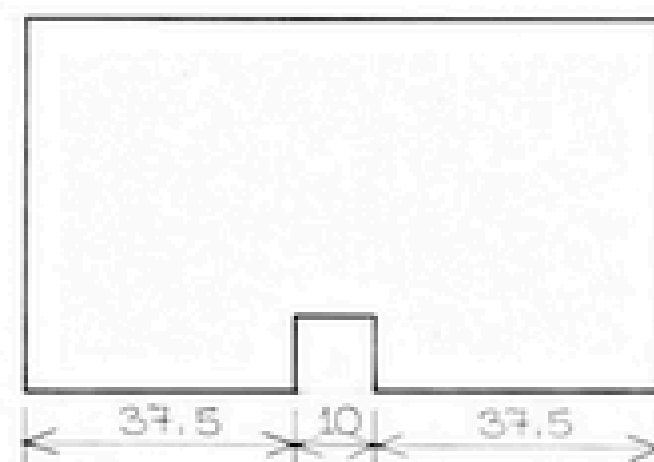
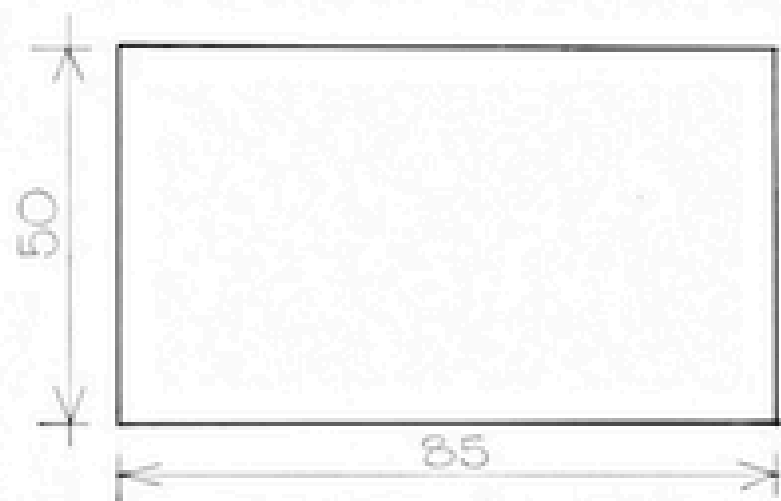

○ □ □	PEÇAS DA BASE	QUANT.: 2 UN
□ □	PROJETO 2 - LUMINÁRIA	ESC: 1:1 UN: mm
□ □ □	PROJETISTA: BEATRIZ VIEIRA	FOLHA: 2/3
□ □	ORIENTADORA: MALARA CAMILO	DESIGN-IFSC

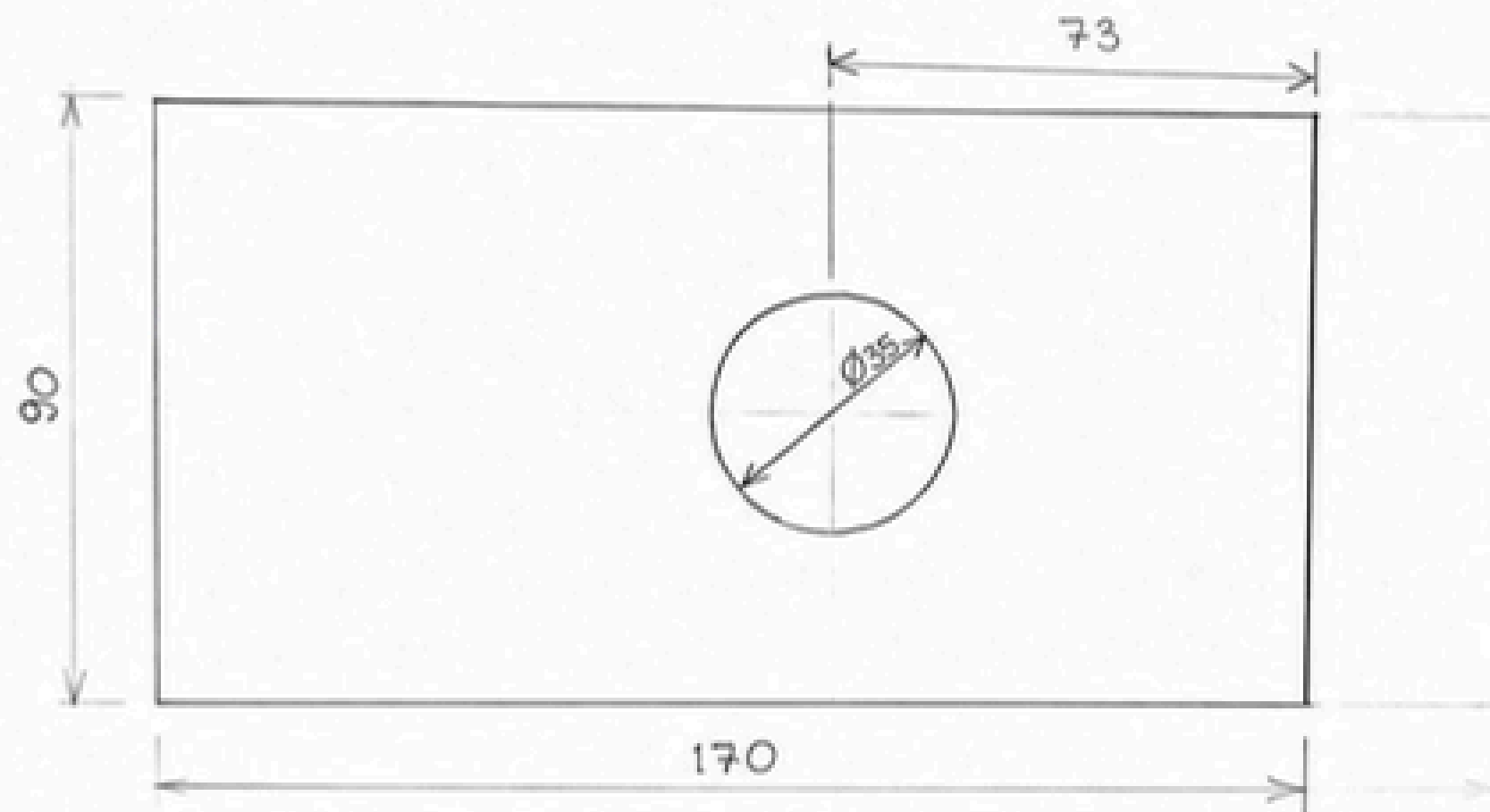

○ □ □	PEÇA CENTRAL	MATERIAL: MDF
□ □	PROJETO 2 - LUMINÁRIA	ESC: 1:1/UN:mmm
□ □ □	PROJETISTA: BEATRIZ VIEIRA	FOLHA: 3/3
□ □	ORIENTADORA: MAIARA CAMILO	DESIGN - IFSC

MOOD BOARD

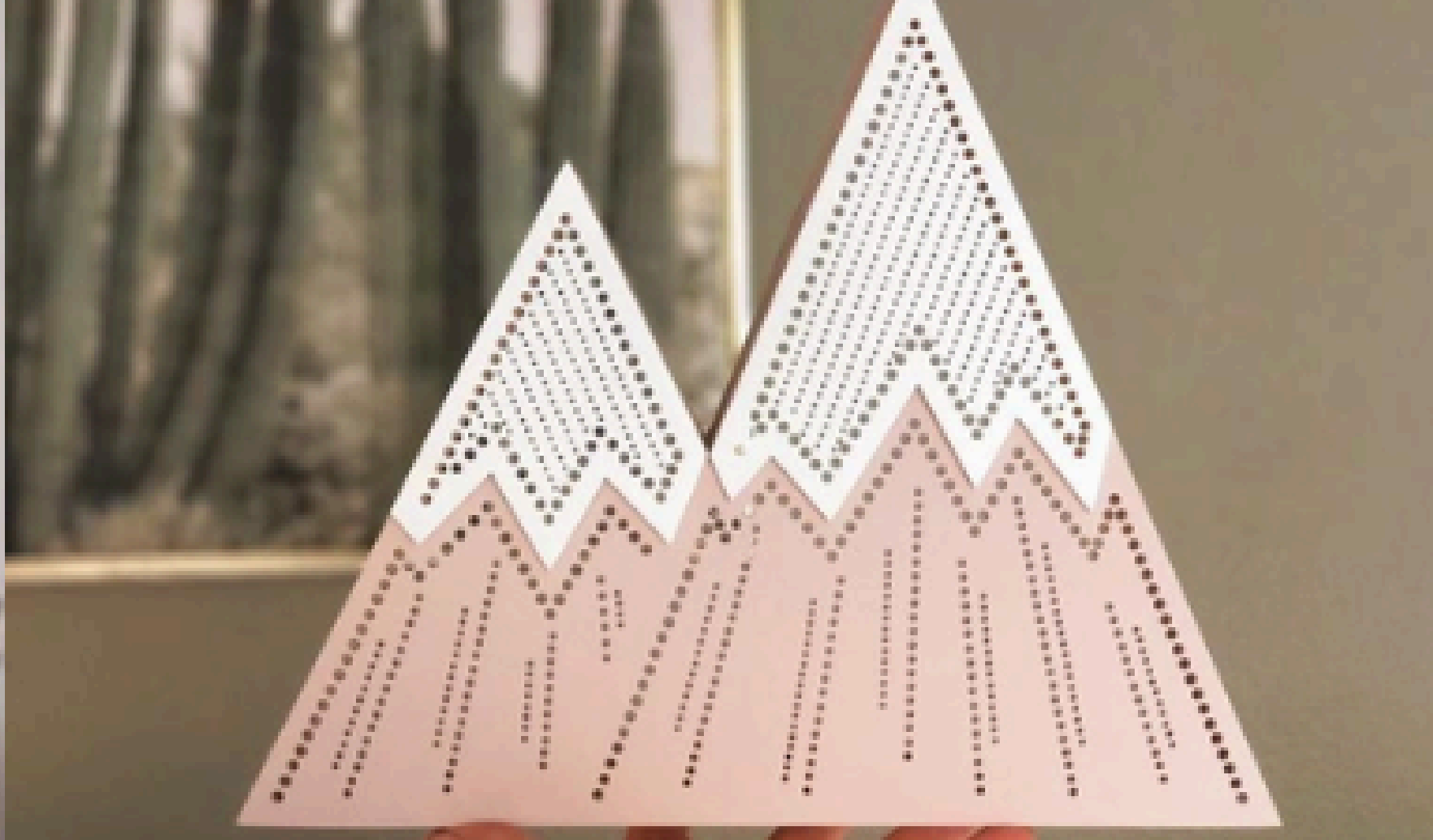

MODELO VOLUMETRICO



CORTE

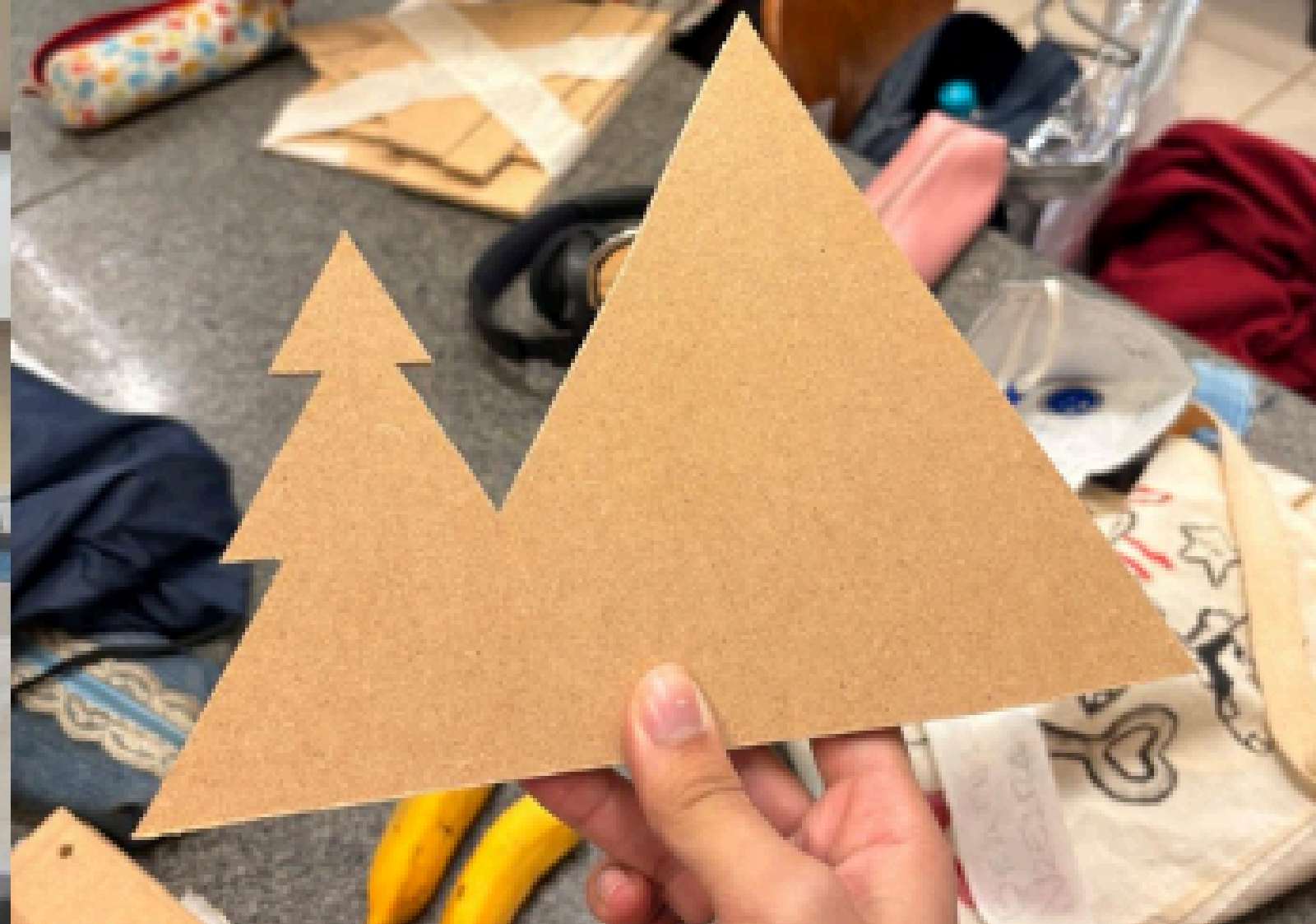

COLAGEM

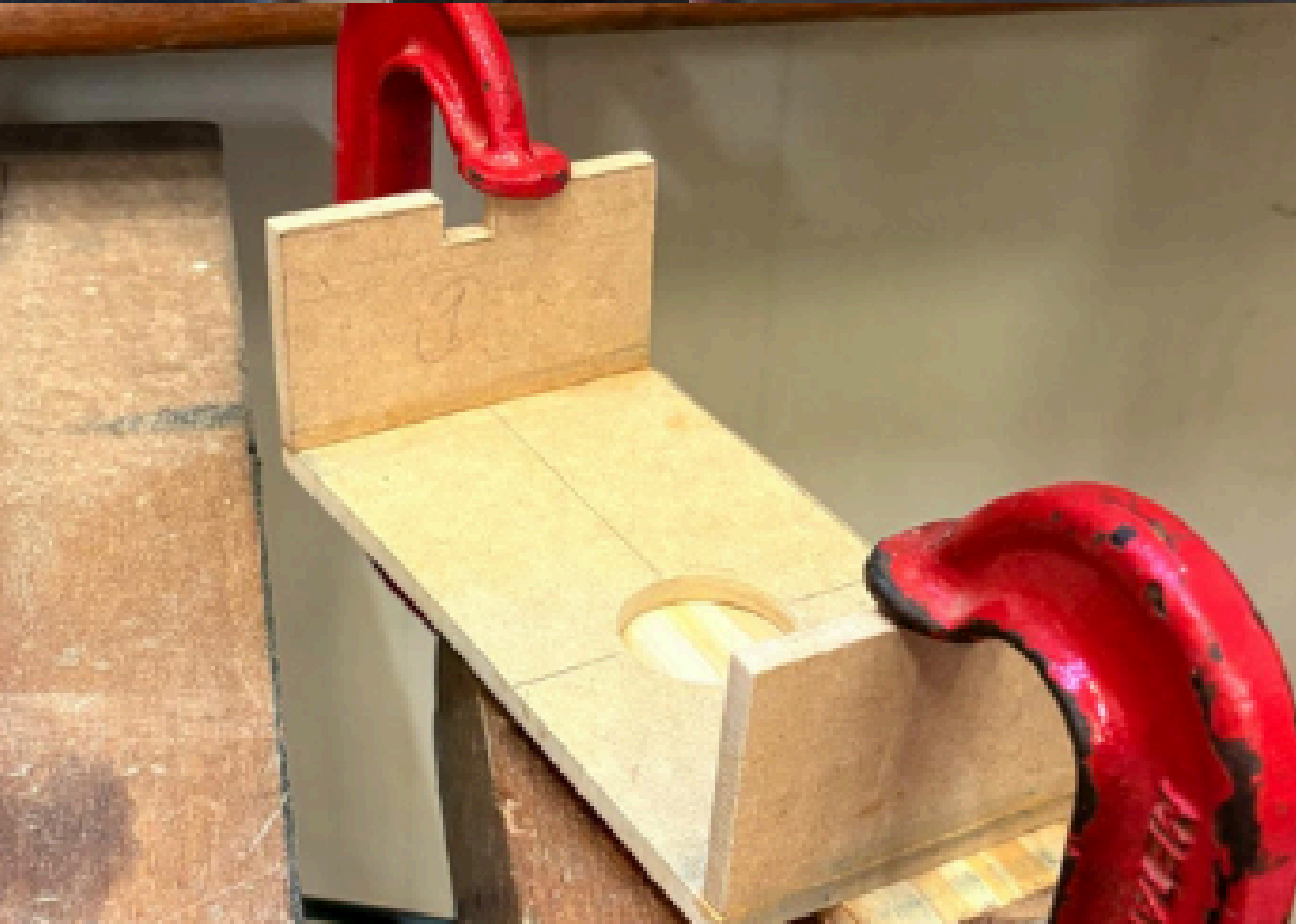



FINALIZAÇÃO





